

Single Pole
Harsh Environment/
Navy Marine

Limit Switches

Butt/ Sliding Contacts

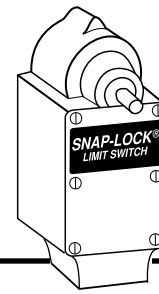

Limit Switches

NAVY meets MIL-C-2212F

Construction — Completely fabricated from non-corrosive materials, its bronze housing and high quality stainless steel shaft insure against external damage to the switch from salt spray corrosive elements. Sealing against leakage is achieved through the use of high quality gaskets on machined surfaces and "O" ring protection, plus close tolerance between the shaft and bushing.

Durability — All internal components are of high grade stainless steel or copper alloy, chrome plated when required, to protect against bearing surface wear and to provide millions of operations.

Both the EA780 and EA790 series switches have heavy duty electrical contacts. The EA780 switches have sliding, double break type contacts built to meet the high shock requirements outlined in MIL-S-901.

EA790 switches have heavy duty, double break butt type contacts.

Contacts — EA780 switches contain sliding contact arrangement which wipe clean with each operation.

EA790 switches contain butt style contacts.

Both series available with operation direction CW, CCW or CW/CCW.

Levers — A variety of corrosion resistant levers are available to meet specific actuating requirements.

NOTE: Levers must be ordered as separate items. See Operating Levers Section.

EA780 Single Pole 1 N.O. - 1 N.C. / Sliding Contacts / Cam Action

Standard Mounting Model No.	Wide Mounting Model No.	Long Mounting Model No.	Dir. Of Operation	Angle A Trip Travel	Angle B Reset Travel	Angle C Recom. Travel	Angle D Total Travel	Angle E Min. Travel to Maintain	Angle F Overall Travel	Torque (inch lbs)	Contact Config.	Data Drawing
STANDARD TRAVEL												
EA780-10000	EA780-40000	EA780-70000	CW	18°	14°	30°	90°	-	-	15	A	1
EA780-10001	EA780-40001	EA780-70001	CCW	18°	14°	30°	90°	-	-	15	B	1
EA780-10100	EA780-40100	EA780-70100	CW/CCW	18°	14°	30°	90°	-	-	15	C	1
MAINTAINED CONTACTS & LEVER POSITION												
EA780-16000	EA780-46000	EA780-76000	CW	55°	22°	60°	116°	55°	64°	6	D	2
			CCW	25°	25°	60°	124°	54°	56°	9		
MAINTAINED CONTACT-LEVER RETURNED												
EA780-16700	EA780-46700	EA780-76700	CW	30°	26°	45°	90°	30°	-	12	D	3
			CCW	16°	30°	45°	90°	26°	-	13.5		

See Operating Levers Section

EA780/EA790

EA790 Single Pole 1 N.O. - 1 N.C. / Butt Contacts / Cam Action

Standard Mounting Model No.	Wide Mounting Model No.	Long Mounting Model No.	Dir. Of Operation	Angle A Trip Travel	Angle B Reset Travel	Angle C Recom. Travel	Angle D Total Travel	Angle E Min. Travel to Maintain	Angle F Overall Travel	Torque (inch lbs)	Contact Config.	Data Drawing
STANDARD TRAVEL												
EA790-10000	EA790-40000	EA790-70000	CW	18°	14°	30°	90°	-	-	15	A	1
EA790-10001	EA790-40001	EA790-70001	CCW	18°	14°	30°	90°	-	-	15	B	1
EA790-10100	EA790-40100	EA790-70100	CW/CCW	18°	14°	30°	90°	-	-	15	C	1
MAINTAINED CONTACT & LEVER POSITION												
EA790-16000	EA790-46000	EA790-76000	CW	55°	22°	60°	116°	55°	64°	6	D	2
			CCW	25°	25°	60°	124°	54°	56°	9		
MAINTAINED CONTACT-LEVER RETURNED												
EA790-16700	EA790-46700	EA790-76700	CW	30°	26°	45°	90°	30°	-	12	D	3
			CCW	16°	30°	45°	90°	26°	-	13.5		
SHORT TRAVEL												
EA790-10900	EA790-40900	EA790-70900	CW/CCW	13°	10°	30°	90°	-	-	15	C	1
NEUTRAL POSITION - ALL CONTACTS OPEN												
EA790-15700	EA790-45700	EA790-75700	CW	31°	12°	45°	90°	-	-	15	E	1
			CCW	31°	22°	45°	90°	-	-	19.5		
NEUTRAL POSITION - ALL CONTACTS CLOSED												
EA790-15800	EA790-45800	EA790-75800	CW	31°	12°	45°	90°	-	-	15	F	1
			CCW	31°	22°	45°	90°	-	-	15		

Limit Switches

Common Switch Characteristics

SINGLE POLE, HARSH ENVIRONMENT NAVY MARINE, BUTT/SLIDING CONTACTS		
	EA780	EA790
NEMA Enclosure Type	1, 4, 4X, 6, 6P, 13	
Housing Material	Bronze	
Ambient Temperature Range*	-20°C to +90°C	
Shipping Weight	4 lbs. approx.	
Lever Adjustment	7°30' Increments thru 360°	
Contacts	Sliding, Silver Alloy Form Z	Butt, Silver Alloy Form Z
Special Switch Features	MIL-C-22122F Watertight (3 ft. for 60 min.) and Submersible (15ft. for 30 min.) per MIL STD-108E Vibration requirements per MIL-STD-167B, Type 1 High Shock per MIL-S-901, grade A, Class 1, type A	

*Some high temperature (0°C to 150°C) and low temperature (-40°C to +90°C) versions available. Contact factory.

EA780

Continuous Current Rating - Amperes

VOLTAGE	AC	DC
125	10.0	2.5
250	7.5	.75
480	5.0	-
600	2.5	-

75-100% Power Factor

EA790

Continuous Current Rating - Amperes

VOLTAGE	AC	DC
125	20.0	5.0
250	15.0	1.5
480	10.0	-
600	5.0	-

75-100% Power Factor



2013 West Meeting Street • Lancaster, SC 29720
1-803-286-8491 • FAX: 1-800-678-6263
www.namcocontrols.com

For technical assistance, call 1-800-NAMTECH

Single Pole
Harsh Environment/
Navy Marine

Limit Switches

Butt/ Sliding Contacts

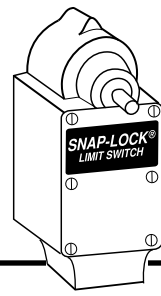

Limit Switches

Contact Configurations

CIRCUIT A

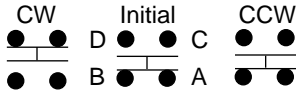

CIRCUIT B

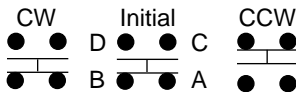

CIRCUIT C

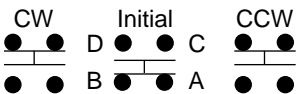

CIRCUIT D

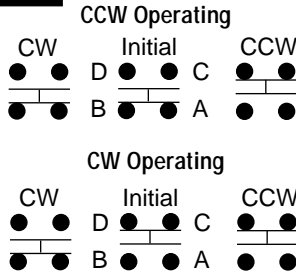

CIRCUIT E

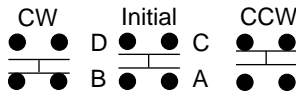

CIRCUIT F

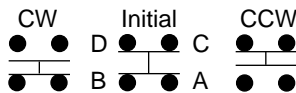

Operational Data Drawings

DRAWING #1

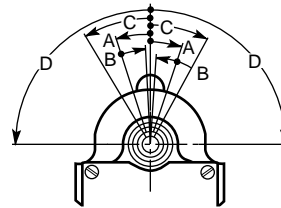

DRAWING #2

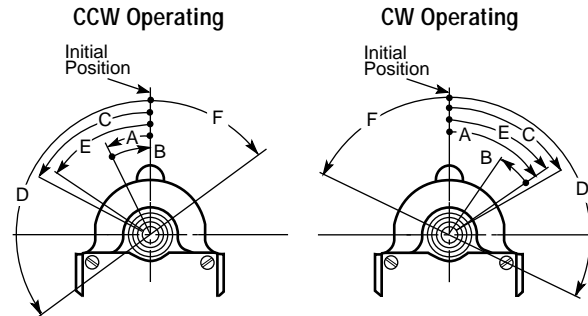

To change switch operation from CW operating to CCW operating, operate switch through angle E. Remove lever and reset at initial position.

DRAWING #3

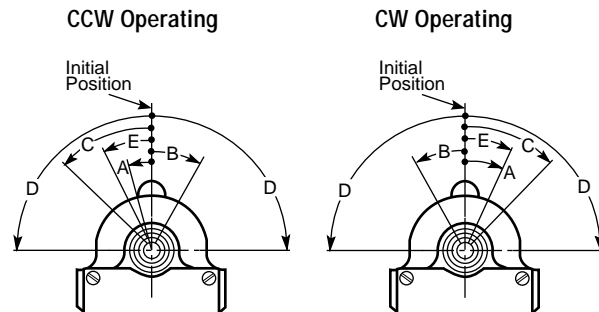

To change switch operation from CW operating to CCW operating, operate switch through angle E.

STANDARD MOUNTING PLATE

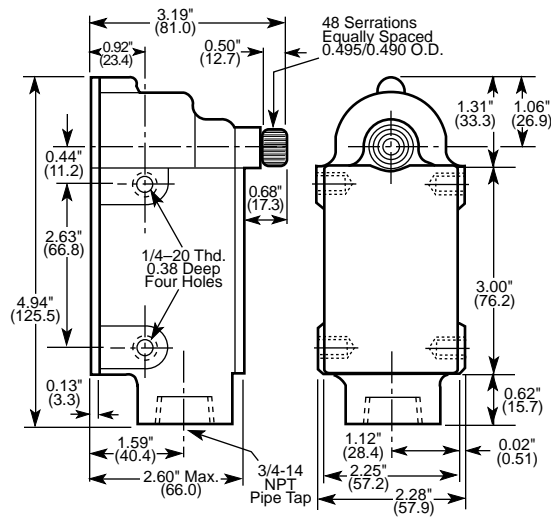

WIDE MOUNTING PLATE

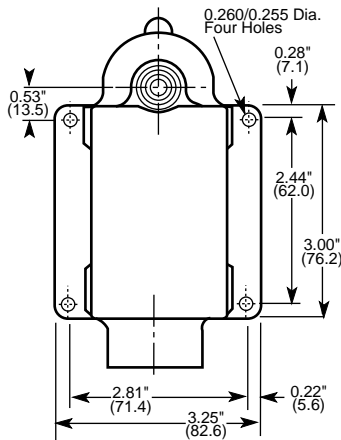

LONG MOUNTING PLATE

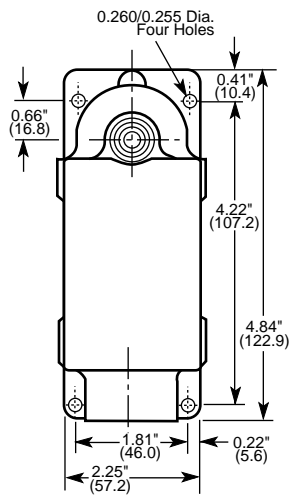

Dimensions: inches/(mm)

NAMCO

2013 West Meeting Street • Lancaster, SC 29720
 1-803-286-8491 • FAX: 1-800-678-6263
www.namcocontrols.com

For technical assistance, call 1-800-NAMTECH